

	Side
Vitriner	3-7
Vægskabe, informationskabe	4-5
Skranker & podier	8-11
Stole og barstole	12
Moduldiske	13-14
Inspiration	15
Instrumentborde	16
Rulleborde	17
Porsastand	18
Porsalet	19
Rillepaneler	20-21
Hyldesystemer	22-23
Lagerinventar	24-26
Profilreoler	24
Kvikreoler	25
Plastkasser	25
Palletreoler	26
Løsdele	27-35
Profiler	27
Samleled	27
Dupsko	28
Tilbehør	28
Porsalet vægskinnesystem	29
Udstillingskasser	29
Porsastand udstillingssystem	29
Belysning	30
Stålvægskinnesystem	30
Papirrullestativer	31
Varekroge og tilbehør	31
Konfektionsinventar	31
Stålgondoler	32
Rørsøjler	32
Kurve	32
Plastkasser	32
Rillepaneler	33
Brochureholdere	34
Gadeskilte	34
Profilreoler og arbejdsborde	35
Kvikreoler	35
Palletreoler	35

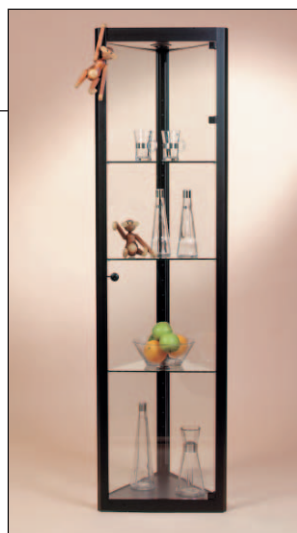

2735 Emil
50 x 50 x H.190 cm



2740 Emma
46 x 46 x 46 cm H.180 cm



2744 Clara
46 x 46 x 46 cm H.190 cm

Vitriner vist på denne side leveres standard med downlight og lås.

- Vitriner kan f.eks bygges som åbne vitriner eller med:
- Underskab
 - Hjul
 - Stilleskruer
 - Belysning efter ønske
 - Ben
 - Spejle
 - Rillepaneler
 - Special plader
 - Logoer påsat
 - Aluprofiler i alle tilgængelige farver.



2725 New Classic
2726 Sara



2731 Ludvig



2727 Oliver



2731 Ludvig
2732 Nikolai
2733 Felix



2725 New Classic
2730 Snow
2726 Sara

2725 New Classic	37x37x180 cm
2726 Sara	37x80x180 cm
2727 Oliver	50x50x200 cm
2730 Snow	37x60x180 cm
2731 Ludvig	37x37x190 cm
2732 Nikolai	37x60x190 cm
2733 Felix	37x80x190 cm
2735 Emil	50x50x190 cm
2740 Emma	46x46x46x180 cm
2744 Clara	46x46x46x190 cm

Vægskabe

Side 4



Vægskabe fremstilles i mål og farve efter ønske.



2671

Vægskabe

2671	Pokalskab			
	Dybde	Længde	Højde	
	25 cm	80 cm	80 cm	
	25 cm	130 cm	80 cm	
	25 cm	160 cm	80 cm	

2672	Pokalskab			
	Dybde	Længde	Højde	
	25 cm	80 cm	92,5 cm	
	25 cm	130 cm	92,5 cm	
	25 cm	160 cm	92,5 cm	

2771	Pokalskab			
	Dybde	Længde	Højde	
	28 cm	100 cm	80 cm	

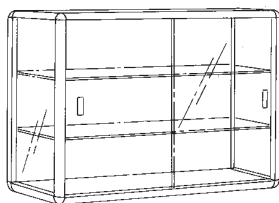

2671

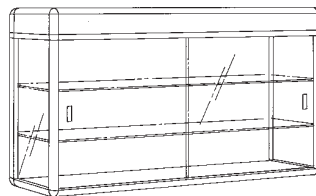

2672

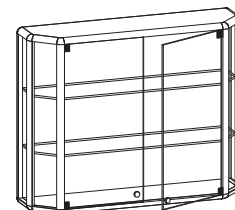

2771

Udhængsskabe

2780	Udhængsskab 50x70 cm
2780	Udhængsskab med lys 50x70 cm
2781	Udhængsskab 70x100 cm
2781	Udhængsskab med lys 70x100 cm
2785	Magnet ø 24 mm



2780



2781



2785



Lågeglas i uv-blokerende akryl eller sikkerhedsglas



Denne side viser blot et udpluk af Porsa Informationskabe. Serien omfatter både inden- og udendørs skabe, med eller uden lys, samt mange størrelser og farver. **Spørg efter komplet brochure.**



Tophængslet informationskab



Informationskab med LED lys



Opstilling efter ønske og behov. Standersæt i matchende farve.



Dobbelt informationskab

Glasvitriner

Side 6



Special opgave for Rosendahl



2694

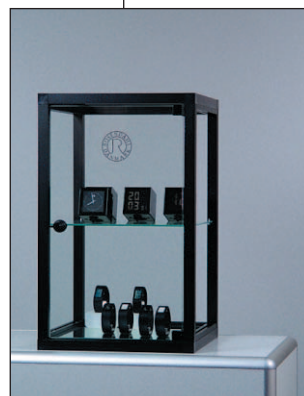

Bordmontre fremstillet for Rosendahl

Vitriner

2673 B 50 cm, L 120 cm, H 100 cm

Højde indv. i skab 30 cm

2674 B 90 cm, L 90 cm, H 88 cm

Højde indv. i skab 20 cm

Inkl. lås

2675 B 50 cm, L 105 cm, H 95 cm

Højde indv. i skab 70 cm

2676 B 50 cm, L 105 cm, H 95 cm

Højde indv. i skab 70 cm

2677 B 50 cm, L 50 cm, H 160 cm

Højde indv. i skab 70 cm

2678 B 50 cm, L 50 cm, H 175 cm

Med baldakin til indbygning af lys

Højde indv. i skab 70 cm

2681 B 50 cm, L 105 cm, H 175 cm

Med baldakin til indbygning af lys

Højde indv. i skab 70 cm

2683 B 50 cm, L 105 cm, H 160 cm

Højde indv. i glasskab 70 cm

Højde indv. i træskab 62 cm

2692 B 50 cm, L 50 cm, H 175 cm

Med baldakin til indbygning af lys

Højde indv. i skabe 70 cm

2694 B 50 cm, L 105 cm, H 160 cm

Højde indv. i skab 70 cm

2697 B 50 cm, L 105 cm, H 168 cm

Højde indv. i skabe 70 cm



2673



2674



2675



2676



2677

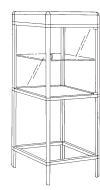

2678



2681



2683



2692



2694



2697



2677



2674



2755

- 2674 B 90 cm, L 90 cm, H 88 cm
- 2677 B 50 cm, L 50 cm, H 160 cm
- 2755 B 48 cm, L 90 cm, H 190 cm

Porsa System har gennem mere end 50 år produceret og leveret dansk kvalitets inventar til stort set hele verden.

Porsa vitriner kendetegnes ved elegant design, produktmæssig kvalitet med lang levetid samt evne til at få dine produkter sat i fokus.

Vi har valgt kun at vise et lille udpluk af vores sortiment, så kontakt os venligst for flere ideer.

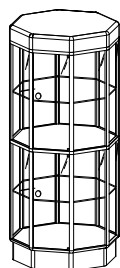

2750

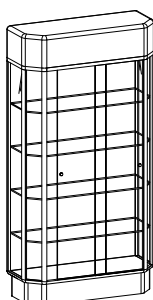

2760

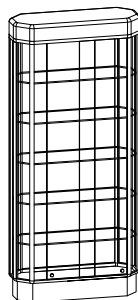

2762

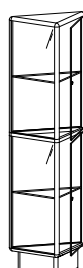

2764

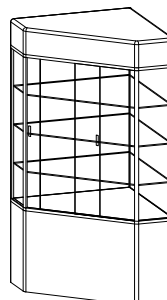

2766

- 2750 B 77 cm, L 77 cm, H 185 cm
- 2760 B 28 cm, L 100 cm, H 200 cm
- 2762 B 39 cm, L 100 cm, H 200 cm
- 2764 B 44 cm, L 60 cm, H 180 cm
- 2766 B 60 cm, L 60 cm, H 200 cm

Skranke & podier

Side 8



Podier, hos Skov & Jacobi A/S, Viborg



1938 Demonstrationsdisk,
med 1 stk. hylde
L 80 cm, B 46 cm, H 94 cm, vægt 9,5 kg
L 100 cm, B 56 cm, H 94 cm, vægt 11,5 kg

Demonstrationsdiske opstilles lynhurtigt
uden brug af værktøj. Spørg efter
transport taske.

Special opgave for Oki og Tupperware



Tupperware salgsvogn som
opstilles i f.eks shoppingcentre.

Salgsvognen leveres i transportkasse
og opstilles uden brug af værktøj.

Skranker leveres i størrelse, farve og med indretning efter ønske.



1980

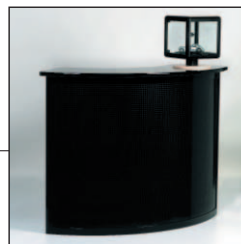

1980 Bueskranke
B 45 cm, L 150 cm, H 110 cm

Eksempler på topplade:
Massivt træ
Lakeret/indfarvet MDF
Glas

Eksempler på front:
Farvet laminatfront
Perforeret træfront
Stålfrent

Eksempler på profilfarve:
Sølv
Sort
Hvid
Alle tilgængelige farver

Eksempler på indretning af skranke:
Hylder
Skuffer
Låger
Papirrullestativ

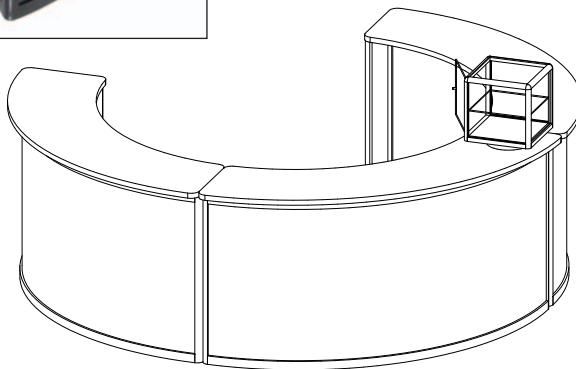

1986 Berlin



1980

Skranker fremstilles altid efter ønske.

Skranker & podier

Side 10



Bueskranke/bar hos Klub Vest, Albertslund



1982 London



Fadølsbar leveret til Ceres, Århus



Fadølsbar leveret til Metalock, Ishøj

Porsa leverer skranke til alle brancher og formål.
Har De specielle ønsker til en skranke, kontakt venligst Porsa for en god idé.



Lys i podie tiltrækker opmærksomhed og fremhæver podie og logo



Det svævende topglas gør podiet let



1984 Skranke med fliser

Design der holder!
Robuste materialer i et enkelt design.

Vi har aludesignet og rigtig mange ideer.

Besøg af vores salgskonsulenter er gratis og uforpligtende.



Skranke fremstillet efter opgave til indskrivningen hos Carsten Andersen Automobiler i Hvidovre

Besøg vores udstillinger og se de mange muligheder i inspirerende miljøer.



Receptionsskranke hos Salonsupport.dk, i Valby



Receptionsskranke



Talerstol
Opbygges i farve og mål efter ønske

Stole og barstole

Side 12



Porsa fører hele det store program af designer stole fra italienske Magis.



6100 Chair One



6106 Stool One



6070 Bombo



6070 Bombo



6070 Alu Bombo



6095 Poppy



6119 Air Chair



6118 Air Chair



6088 Lyra



Diskserie bestående af 1910, 1930, 1905 og 1916 (i nævnte rækkefølge)

Alle moduldiske fås med kvartrunde eller firkantede rør.
 Alle fronter kan monteres med rillepanel.
 Taskehylder, indvendige hylder, låger og lås er ekstra tilbehør hvor det ikke specielt er nævnt som tilbehør.



1905



1906



1907



1914



1909



1910



1911



1916



1918



1900

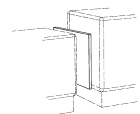

1901



tilbehør



tilbehør



tilbehør

- 1905 Disk
B 50 cm, L 100 cm, H 90 cm
- 1906 Disk med taskehylde
B 50 cm, L 100 cm, H 90 cm
- 1907 Kassedisk
B 50 cm, L 50 cm, H 80 cm
- 1914 Disk med 3-dobbelt bladhyld
B 50 cm, L 100 cm, H 90 cm
- 1909 Disk med 15 cm glasoverdel.
Glas- eller træskydelåger i overdel
B 50 cm, L 100 cm, H 90 cm
- 1910 Disk med 25 cm glasoverdel.
Glas- eller træskydelåger i overdel
B 50 cm, L 100 cm, H 90 cm
- 1911 Glasdisk
1 glashylde og glaslåger
B 50 cm, L 100 cm, H 90 cm
- 1916 Disk med 12 kassetter og glas- eller træskydelåger i glasoverdel
B 50 cm, L 100 cm, H 90 cm
- 1918 Disk med 6 bækker og glas- eller træskydelåger i glasoverdel
B 50 cm, L 100 cm, H 90 cm
- 1900 Mellemlade
B 45 cm, H 70 cm, T 1,9 cm
- 1901 Mellemlade til kassedisk
B 45 cm, H 60 cm, T 1,9 cm
- Tilbehør til Moduldiske:
 - Skydelåger og indvendige hylder
 - Papirrullestativ
 - Skuffer
 - Rillepaneler

Moduldiske

Side 14

Den viste skitse er opbygget af standard moduldiske sammensat med special udviklede moduldiske

 1905, 1906, 1909, 1910, 1911, 1914, 1916, 1918

 1907, 1924, 1926

 1928, 1930

 1962

 1966, 1967

 1968

 Special moduldisk

 Special moduldisk



Diskserie bestående af 1905, 1930/1924, 1910 og 1916

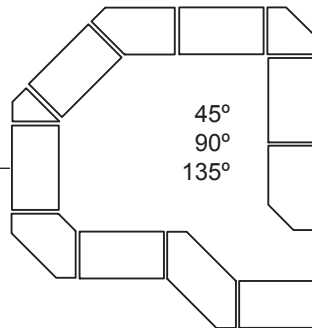

Moduldiske

- 1924 Hjørnedisk
B 50 cm, L 50 cm, H 90 cm
- 1926 Glashjørnedisk med 1 glashylde og glaslåge med lås
B 50 cm, L 50 cm, H 90 cm
- 1928 Skrå hjørnedisk
B 50 cm, L 50 cm, H 90 cm
- 1930 Skrå glashjørnedisk med 1 glashylde og glaslåge med lås
B 50 cm, L 50 cm, H 90 cm
- 1962 Hjørnedisk 45°
B 50 cm, H 90 cm

- 1960 Bagdisk med 1 hylde og låge med lås
B 50 cm, L 120 cm, H 90 cm
- 1961 Glasbagdisk med 1 glashylde og glaslåge med lås
B 50 cm, L 120 cm, H 90 cm
- 1963 Hjørnedisk 135°
B 50 cm, L 120 cm, H 90 cm
- 1966 Hjørnedisk med 1 hylde og låge med lås
B 50 cm, L 120 cm, H 90 cm
- 1967 Glashjørnedisk med 2 glashylder og glaslåge med lås
B 50 cm, L 120 cm, H 90 cm

- 1968 Disk med en 45° side, med 2 glashylder
B 50 cm, L 100 cm, H 90 cm
- 1932 Alt mulig disk til f.eks kioskvarer
B 45 cm, L 85 cm, H 140 cm



1924

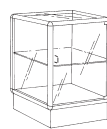

1926

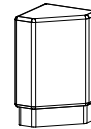

1928

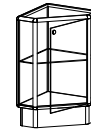

1930



1962

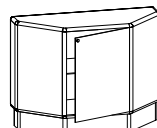

1960



1961

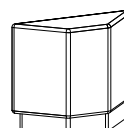

1963

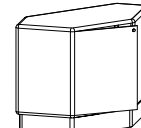

1966

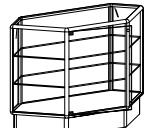

1967



1968



1932



Ekspeditionsdiske hos
Skov & Jacobi, Viborg



Kiosk på hospital



Garmin shop



Fotoforretning

Instrumentborde

Side 16



Rullevogn til EKG
Fremstillet for Kivex A/S



Rullebord



Specialfremstillet rullebord



Rullevogn fremstillet for
Kivex A/S



Rullevogn fremstillet for Triolab A/S



Salgsvogn fremstillet for Adidas

Eksempler på rulleborde



2910

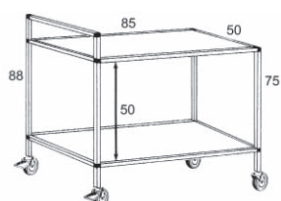

2911



2912

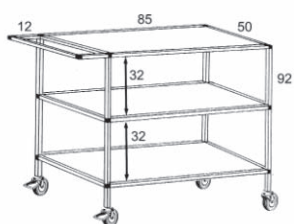

2914



2915

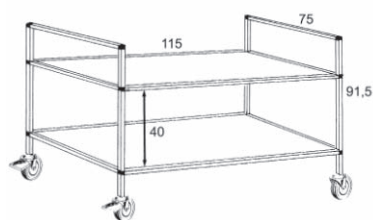

2916

- 2910 Rullebord med 50 mm eller 75 mm hjul
- 2911 Transportbord med 75 mm gummihjul
- 2912 Transportbord med 75 mm gummihjul

- 2914 Transportbord med 3 hylder og 75 mm gummihjul
- 2915 Bogvogn med 75 mm gummihjul
- 2916 Stofvogn med 125 mm gummihjul

Porsastand

Side 18



Porsastand udstillingssystemer samles let ved hjælp af Porsa's aluclips (3800).

Systemet er enkelt at opbygge/nedtage og kan altid ombygges til et nyt design.

Løsdele:

- Profiler side 27
- Dupsko side 28
- Porsalet side 29
- Udstillingskasser side 29
- Løsdele til Porsastand side 29
- Belysning side 30

Søger du råd og vejledning til opbygning af stand, kontakt venligst Porsa.

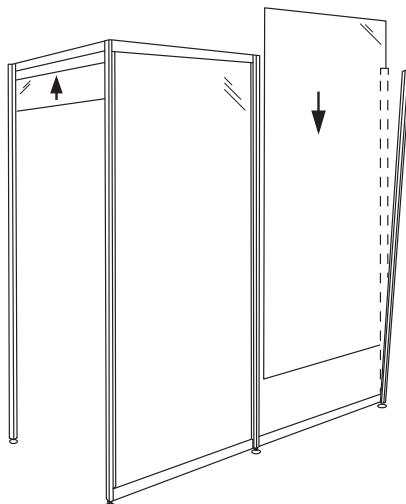

Eksempler på Porsa stande

Eksempler på stande:

- Eksempel 1: Stand 4 x 2 m
- Eksempel 2: Stand med buer 3 x 3 m
- Eksempel 3: Stand 5 x 3 m

Standene fremstilles altid efter ønske.

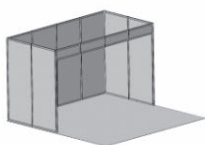

Eksempel 1

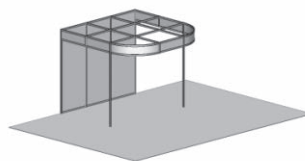

Eksempel 2

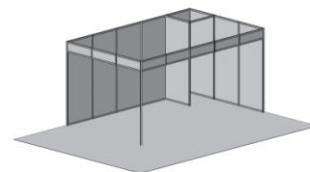

Eksempel 3

Se venligst side 29 eller kontakt Porsa for yderligere information.

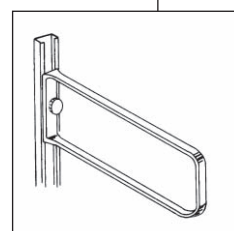
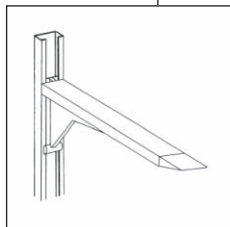

Porsalet aluminium vægskinnesystem har et enkelt design og hylderne indstilles trinføst. Eksempler på hylder: glas, træ, metal, skrå tidsskrift hylde m.v.

Hylde se side 30.



Enkelt/dobbelt gondolstel opbygges efter mål og kan kombineres med porsalet vægskinnesystem. Bagbeklædning kan f.eks være: træplade, metalplade, hulplade, spejl m.v.

Max belastning: 150 kg. pr. fag.

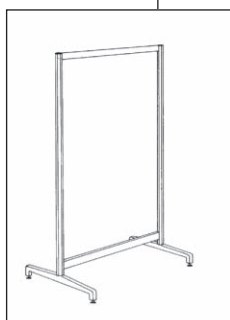

Porsalet aluminium vægskinnesystem her med glashylder og skabe

Rillepaneler

Side 20



Photocare, København V



Cykelforretning



2660

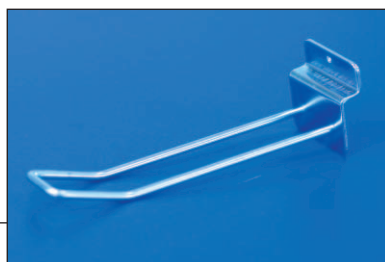

Løsele se side 33



Podie med perforerede hylder



Rillepaneler i bijouteriforretning, København



Udstillingspodier

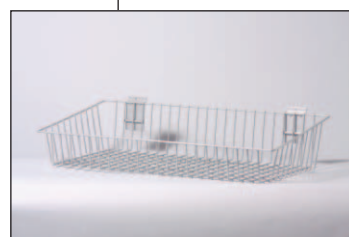
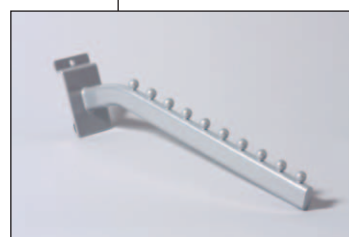

Løsele se side 33



Hyldesystemer

Side 22

Porsa har praktiske og bæredygtige løsninger når dit varesortiment skal præsenteres.



Kop & Kande, Nexø



Kop & Kande, Nexø



Rødovre Boligmontering



- Løsdele:
- Vægskinner side 30
 - Hyldeknægte side 30
 - Hylde side 30

Søger du råd og vejledning til indretning, kontakt venligst Porsa.

Stålgondoler



Stålgondoler med trådhylder er praktisk til det brede produktsortiment, eller tunge emner. Skov & Jacobi, Viborg

Løsdeler:

- Stålgondoler side 32
- Melamin- og stålhylder side 30
- Trådhylder og -kurve side 30

Søger du råd og vejledning til indretning, kontakt venligst Porsa.

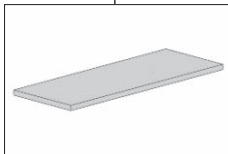

Enkelt gondolstel med metalhulplade, plastkasser og stålhylder



Dobbelt gondolstel med trådkurv, tråd-, sko- og ølkassehylde

Profilreol



Factory Outlet, Royal Scandinavia



Factory Outlet, Royal Scandinavia



5000 Profilreol



5000 Profilreol



5000 Profilskab

5000 Profilreol/profilskab
Max belastning pr. hylde 75 - 100 kg.
Farve: hvid eller grå.

Se venligst side 35 eller kontakt
Porsa for yderligere information.

Kvikreol

Vi gi'r dig 3 gode grunde til at vælge en Porsa Kvikreol:

- Boltløs

samles hurtigt og nemt, uden brug af andet værktøj end en lille hammer.

- Galvaniseret

du har en reol der holder i mange år, indendørs såvel som udendørs.

- Stabil

ingen brug af kryds på bagside. Vedhæftningen af hyldeprofiler gør, at Kvikreolen står lige så stabilt som en reol samlet med bolte !



Kvikreol leveres i flere hyldebredder:
30, 40, 50, 60 og 80 cm.
Længde pr. fag 100 cm.

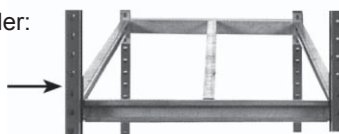

Antal hylder og antal fag efter eget ønske.

Hyldeplade:
3 mm grå lakeret
fiberplade.



Belastningsevne 135 kg. pr. hylde.

Højde 200 og 250 cm.

Der er mulighed for at forhøje reolen med forlængerstykker, samt at bygge reolerne sammen på længdesiden med samlebolt.

Kvalitet behøver ikke at koste mere !

Løsdele side 35

Plastkasser



Se vores udvalg i plastkasser
på side 32



Palletreol



8000 Palletreol
Lagerindretning
hos Solåe, Århus



8000 Palletreol



8000 Palletreol
Belastningsevne:
700 - 900 kg pr. hylde.

Farve: Grågrøn

Se venligst side 35 eller kontakt
Porsa for yderligere information.



Max belastningsevne pr. hylde 700 - 900 kg.

Profiler

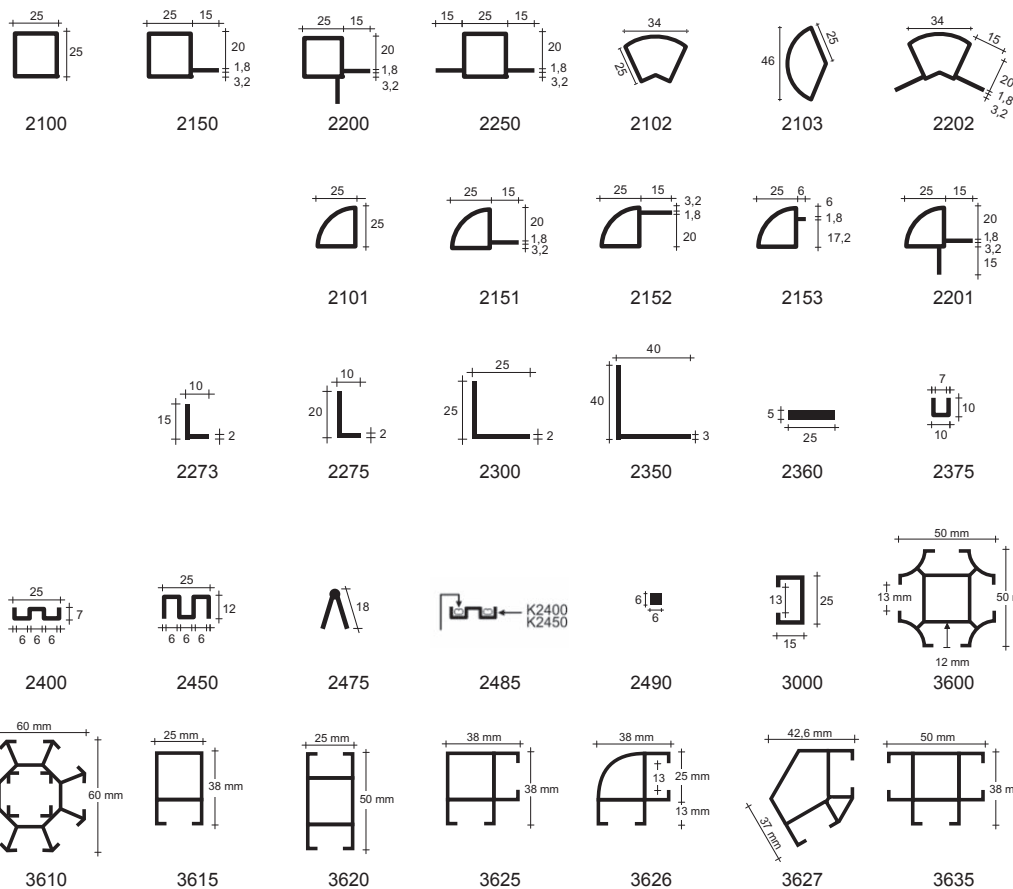

- 2100 Rør uden flig
- 2150 Rør med 1 flig
- 2200 Rør med 2 flige vinkel
- 2250 Rør med 2 flige lige
- 2102 Rør uden flig 135 grader
- 2103 Rør uden flig 45 grader
- 2202 Rør med 2 flige 135 grader

- 2101 Rør uden flig kvartrund
- 2151 Rør med 1 flig kvartrund
- 2152 Rør med 1 flig kvartrund
- 2153 Rør med 1 flig kvartrund til 5 mm glas
- 2201 Rør med 2 flige vinkel kvartrund

- 2273 Vinkel 10 x 15 x 2 mm
- 2275 Vinkel 10 x 20 x 2 mm
- 2300 Vinkel 25 x 25 x 2 mm
- 2350 Vinkel 40 x 40 x 3 mm
- 2360 Fladprofil 5 x 25 mm
- 2375 U-profil 10 x 10 x 2 mm

- 2400 Underliste til skydedøre/sideglas
- 2450 Overliste til skydedøre/sideglas
- 2475 Pianohængsel 18 x 18 mm
- 2485 Plastgledeliste til glasskydedøre
- 2490 Alustang 6 x 6 mm sort
- 3000 Vægskinne 15 x 25 mm
- 3600 Søjle 4 sidet

- 3610 Søjle 8 sidet
- 3615 Rør 1 sidet
- 3620 Rør 2 sidet lige
- 3625 Rør 2 sidet vinkel
- 3626 Rør 2 sidet vinkel med bue
- 3627 Rør 2 sidet 60 grader
- 3635 Rør 3 sidet

Profiler lagreføres i farverne: sølv, sort, hvid.
Længde: 500 cm

Samleled

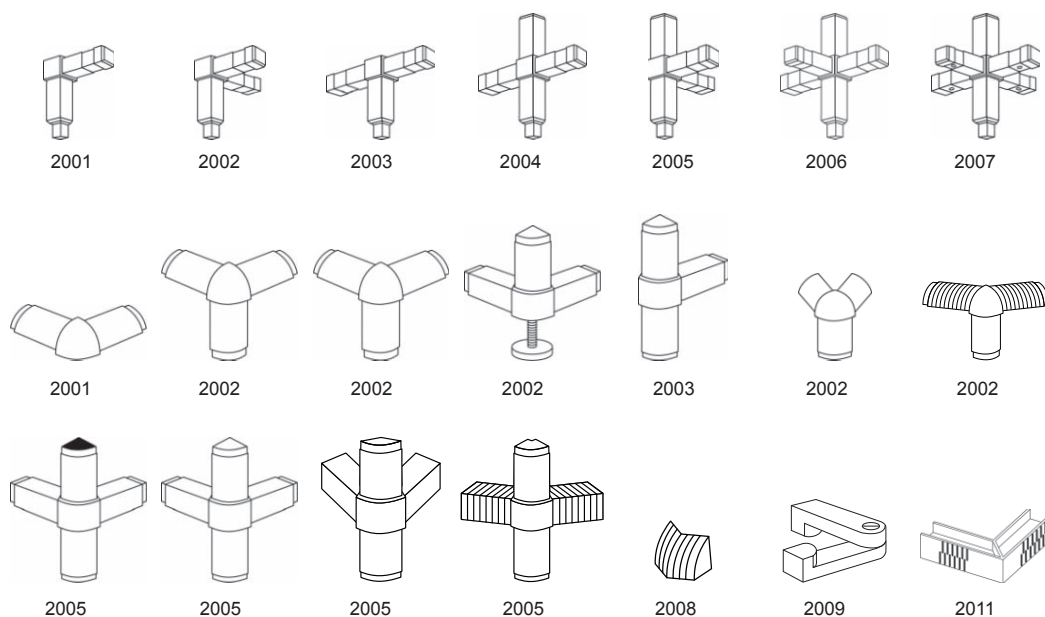

- 2001 Samleled 2 grene
- 2002 Samleled 3 grene vinkel
- 2003 Samleled 3 grene flad
- 2004 Samleled 4 grene flad
- 2005 Samleled 4 grene vinkel
- 2006 Samleled 5 grene
- 2007 Samleled 6 grene

- 2001 Samleled 2 grene
- 2002 Samleled 3 grene vinkel m. aluindlæg
- 2002 Samleled 3 grene vinkel
- 2002 Samleled 3 grene vinkel med M10 gevind
- 2003 Samleled 3 grene flad
- 2002 Samleled 3 grene vinkel 45 grader
- 2002 Samleled 3 grene vinkel 135 grader

- 2005 Samleled 4 grene vinkel m. aluindlæg
- 2005 Samleled 4 grene vinkel
- 2005 Samleled 4 grene vinkel 45 grader
- 2005 Samleled 4 grene vinkel 135 grader
- 2008 Samleled 2 grene 135 grader indvendig
- 2009 Bevægelig samleled
- 2011 Indvendigt samleled 90 grader

Samleled lagreføres i farverne: sølv, sort, hvid.

Løsdele

Side 28

Dupsko

- 2020 Dupsko 25 x 25 mm
- 2020 Dupsko 25 x 25 mm kvartrund
- 2021 Dupsko med M10 gevind
- 2021 Dupsko med M10 gevind kvartrund
- 2021 Dupsko med M10 gevind 45 grader
- 2021 Dupsko med M10 gevind 135 grader
- 2022 Dupsko 40 x 40 mm
- Ekskl. stilleskrue se nedenfor (2025)**

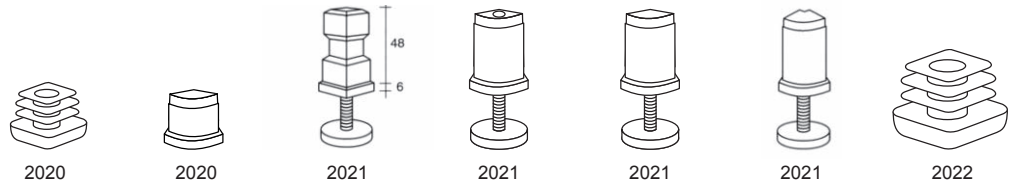

- 3700 Dupsko til 3600
- 3710 Dupsko til 3610
- 3715 Dupsko til 3615
- 3720 Dupsko til 3620
- 3725 Dupsko til 3625
- 3726 Dupsko til 3626
- 3727 Dupsko til 3627 med M10 gevind

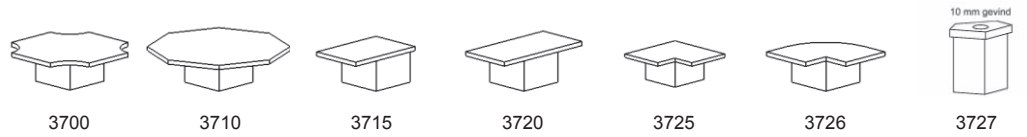

- 3735 Dupsko til 3635
- 1643 Dupsko til Gondol til 1630/1640
- 3170 Snabel til 3000

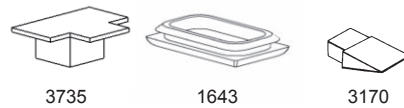

Kontakt venligst Porsa for andre dupsko

Tilbehør

- 2016 Rekylfri hammer
- 2023 Glashængsel til store glassdøre
- 2024 Alu-hængsel
- 2025 Stilleskrue med 10 mm gevind
- 2026 Rund glassås til 5 mm glas
- 2027 Lille glashængsel
- 2027 Mellemhængsel



- 2028 Lås med drejelig pal
- 2029 Trykcyllinderlås til træskydelåger
- 2030 Glaslås
- 2031 Dom lås
- 2032 Koblingklips til saml. af kubusrammer
- 2034 Hyldebærer

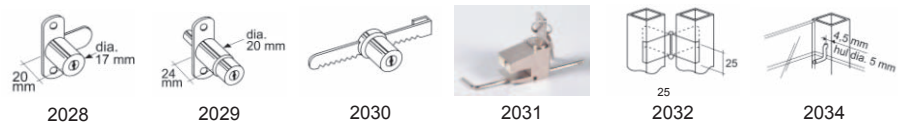

- 2042 Bolt 10 mm
- 2043 Benstøtte
- 2044 Unbraconøgle til gummi-hjul
- 2045 Bordbensplade i aluminium
- 2046 Ringgaffelnøgle 13 mm
- 2050 Gummitap til glashylde selvkøbende
- 2051 Monteringsplade til Levina hjul

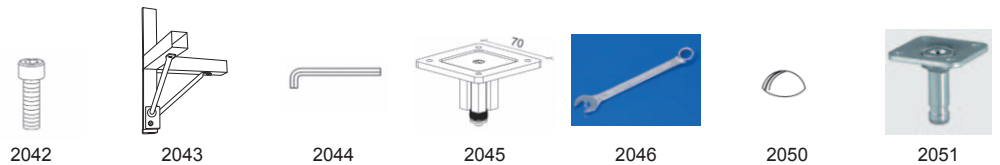

- 2060 Plasthjul Ø 50 mm
- 2061 Gummi-hjul Ø 50 mm
- 2062 Gummi-hjul Ø 50 mm m.plade
- 2064 Gummi-hjul Ø 75 mm m.plade
- 2065 Gummi-hjul Ø 75 mm
- 2066 Gummi-hjul Ø 125 mm



- 2067 Gummi-hjul Ø 125 mm m.plade
- 2070 Gummi-hjul Ø 125 mm sort
- 2071 Gummi-hjul Ø 125 mm sort fast
- 2075 Hjul Levina Ø 75 mm grå/sort
- 2076 Hjul Levina Ø 100 mm grå/sort/hvid
- 2077 Hjul Levina Ø 125 mm grå/sort/hvid



Alle hjul fås med/uden bremse

Porsalet vægskinner med tilbehør

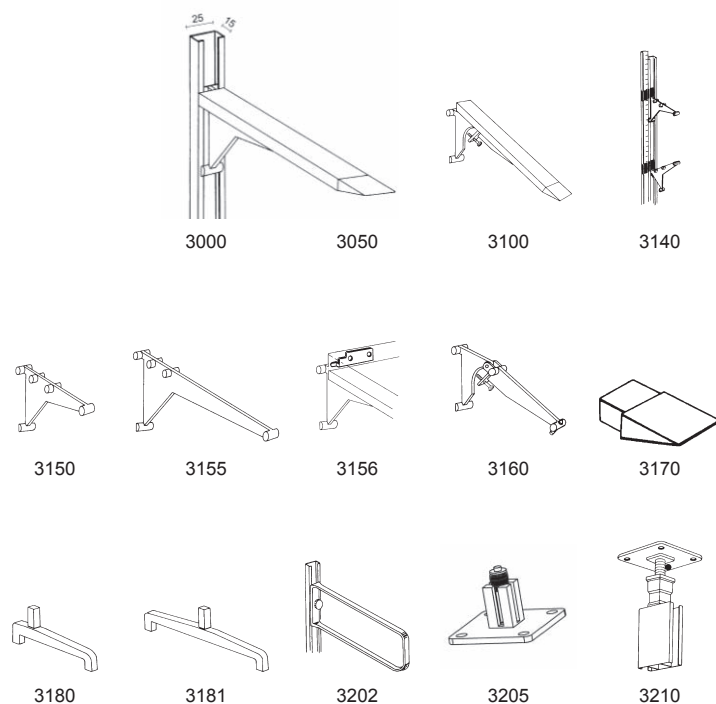

- 3000 Vægskinne, 50, 100, 150, 200, 250, 500 cm
- 3050 Hyldeknægt 15, 20, 25, 30, 40 cm
- 3100 Hyldeknægt med smig 20, 30 cm
- 3140 Monteringslineal

- 3150 Bagknægt 10,5 cm
- 3155 Bagknægt 29 cm
- 3156 Hyldeholder til lige hylder
- 3160 Bagknægt med smig
- 3170 Snabel til 3000

- 3180 Enkelt gondolfod
- 3181 Dobbelt gondolfod
- 3202 Bogstøtte L. 25 cm H. 10 cm
- 3205 Underflange
- 3210 Overflange med gevindbøsning og møtrik

Udstillingskasser

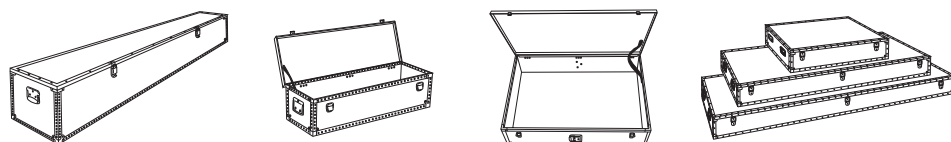

- 3550 Udstillingskasse 1040 x 270 x 200 mm
- 3550/1 Udstillingskasse 1040 x 1040 x 150 mm
- 3550/2 Udstillingskasse 2570 x 285 x 200 mm
- 3550/3 Udstillingskasse 2550 x 1040 x 110 mm
- 3550/5 Udstillingskasse 1040 x 760 x 220 mm

Alle mål er indvendige.
Udstillingskasserne kan også leveres i specialmål med eller uden foring.
Forlang tilbud

Porsastand udstillingssystem

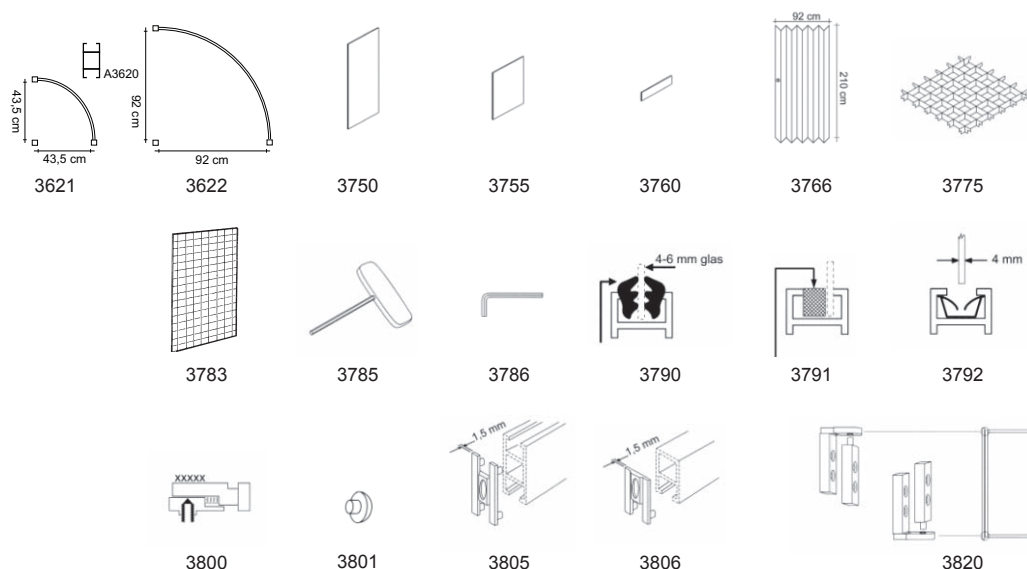

- 3621 1/4 Bue lille, buelængde indv. 71,2 cm
- 3622 1/4 Bue stor, buelængde indv. 147,4 cm
- 3750 1/1 Vægplade let/melamin 94,4 x 237,4 cm (Lysmål minus 2,4 cm)
- 3755 1/2 Vægplade let/melamin 94,4 x 121,4 cm (Lysmål minus 2,4 cm)
- 3760 Baldakinplade let/melamin 94,4 x 24,4 cm (Lysmål minus 2,4 cm)
- 3766 Foldedør til porsastand 210 x 92 cm
- 3775 Fletloft grå 100x100 cm sammenklappelig

- 3783 Dekorationsgitter 94,5 x 100 cm
- 3785 Unbraco T-nøgle
- 3786 Lille unbraco nøgle
- 3790 Gummiliste (2 m. for hver m. glaskant)
- 3791 Skumgummiliste
- 3792 Plastliste til 4 mm glas/plader L. 500 cm

- 3800 Aluclips samlebeslag
xxxx skal smøres med konsistensfedt
- 3801 Dæktap til aluclips
- 3805 Beskyttelseskrave til 3620
- 3806 Beskyttelseskrave til 3615
- 3820 Dørhængsel til porsastandprofiler

Løsdele

Side 30

Belysning

- 3825 Strømskinne
100, 150, 200, 300 cm. Sort/hvid/sølv
- 3833 Tilslutning
- 3837 Samlestykke
- 3845 Vinkelstykke - flex
- 3849 Endestykke
- 3857 Transformer elektro 60, 105 W.
- 3863 Transformer mekanisk 200, 300 W.
- 3863 Spot med adapter

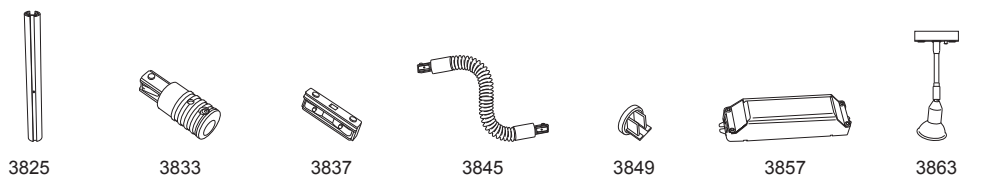

- 3867 Downlight 20 W. Sort/hvid
- 3869 Downlight kipbar Sort/hvid
- 3871 Stiftpære 20 W.
- 3873 Koldspejlspære 20, 35, 50 W.
- 3920 Messespot 50 W. Arm L. 50 cm
- 3935 Kabelroset Ø 60 mm. Grå/sort/hvid
- 3936 Kabelroset Ø 80 mm. Sort/hvid

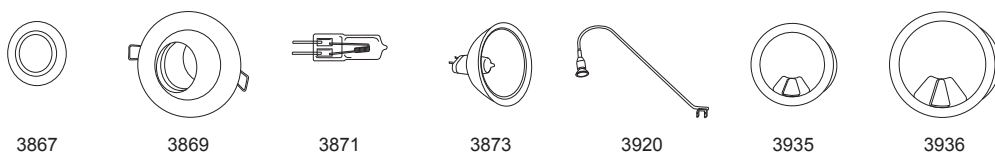

- 3950 LED strip 0,8 watt, kold/varm hvid
- 3955 LED downlight 1,1 watt kold hvid
- 3960 LED driver 15W, 30W, 50W
- 3962 Fordelingsdåse 4 eller 6 udgange
- 3964 Forbindelseskabel 2,5 m.
- 3966 Samlestykke

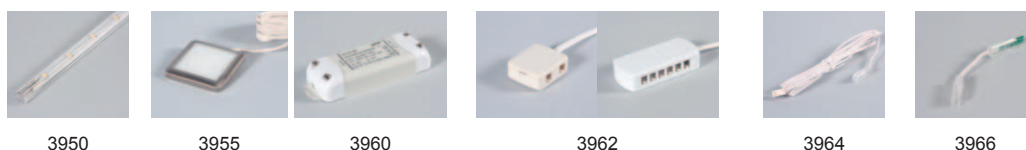

Stålvægskinnesystem

- 1000 Vægskinne
50, 100, 150, 200, 250 cm
- 1050 Underkonsol til træhylde
20, 30, 40, 50 cm
- 1100 Underkonsol med smig til træhylde
20, 30, 40 cm
- 1200 Støtteknægt til træhylde
20, 30 og 40 cm
- 1250 Underkonsol til metalhylde
20, 30, 40 cm
- 1300 Støtteknægt til metalhylde
20, 30, 40 cm
- 1310 Smigknægt til metalhylde
- 1311 Smigknægt til metalhylde 45 grader

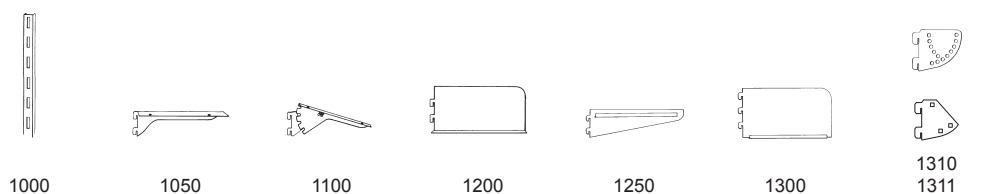

- 1320 Trådhylde chrom/hvid
L. 80 cm B. 30, 40, 50 cm
- 1330 Skillerum til trådhylde chrom/hvid
30, 40, 50 cm
- 1340 Knægt til trådhylde 30, 40, 50 cm
- 1350 Trådkurv chrom L. 80 cm B. 30, 40 cm
- 1360 Skillerum til trådkurv 30, 40 cm
- 1361 Dataliste til trådhylde L. 80 cm
- 1362 Dataliste selvklæbende L. 80 cm



- 1365 Skohylde L. 80 cm
- 1370 Ølkassehylde L. 80 cm
- 1373 Bogstøtte til metalhylde
- 1375 Bogstøtte til metalhylde
- 1377 Bogstøtte
- 1379 Ringbindstøtte
- 1395 Klar plexiforkant 5 x 80 cm
- 1397 Vinkelliste til montering af 1395



- 1402 Bladhylde enkelt L. 80 cm
- 1403 Bladhylde 3 dobbelt L. 80 cm
- 1420 Metalhylde L. 80 cm B. 20, 30, 40 cm
- 1430 Hvid melamin hylde
L. 80 cm B. 20, 30, 40, 50 cm
- 1440 Farvet melamin hylde
L. 80 cm B. 20, 30, 40, 50 cm
- 1470 Melamin med træstruktur
L. 80 cm B. 20, 30, 40, 50 cm
- 1480 Glashylde 6 mm
L. 80 cm B. 20, 30, 40 cm

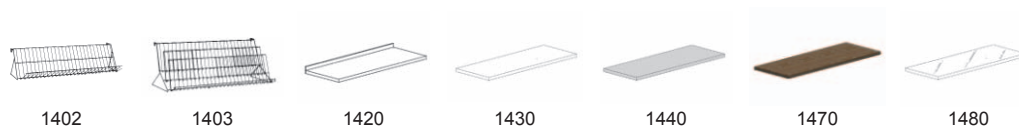

Papirrullestativer



1381/1



1381/6



1381/8



1381/9



1382

- 1381/1 Papirrullestativ/gulvmodel 40, 60, 75 cm
- 1381/6 Papirrullestativ/vægmodel 40, 60, 75 cm
- 1381/8 Papirrullestativ/til ophæng under bordplade 40, 60, 75 cm
- 1381/9 Papirrullestativ/tilbygningsfag 40, 60, 75 cm
- 1382 Båndrullestativ med kniv

Varekroge og tilbehør



1489

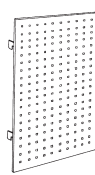

1490



1495

- 1489 Ophængsbeslag
- 1490 Metalhulplade 77,3 x 98,6 cm
- 1495 Panelstang 80 cm (til panelkroge)



1500



1505



1510

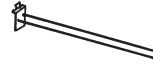

1530

- 1500 Ophængsspind til masonitehulplade 5, 10, 15, 20 cm
- 1505 Varekrog 3 mm 1,2 cm
- 1510 Varekrog 5 mm 5, 10, 15, 20, 25, 30 cm
- 1530 Dobbelt krog 5 mm 10, 15, 20, 25 cm
- Dobbelt krog 7 mm 10, 15, 20, 25 cm

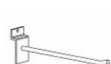

1545



1555



1556



1580



1581



1582



1584

- 1545 Panelkrog 5, 10, 15, 20, 25, 30 cm
- 1555 Netbeslag 5, 10, 15, 20, 25, 30 cm
- 1556 Fjederklemme 1, 2 cm
- 1580 Euro-krog til hulplade 5,10,15,20,25,30 cm
- 1581 Euro-krog til net 5,10,15,20,25,30 cm
- 1582 Euro-krog til net 5,10,15,20,25,30 cm
- 1584 Dataskilt til euro-krog

Skruer og rawplugs



1590



1592



1597

- 1590 Skrue og rawplugs 8 sæt
- 1592 Hyldekrue 24 stk.
- 1597 Expandet rawplugs

Konfektionsinventar



1600



1601



1602



1603

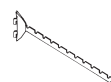

1605

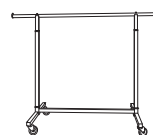

1609

- 1600 Konfektionsrør 80, 250 cm
- 1601 Konfektionsknægt
- 1602 Konfektionsudtræk
- 1603 Garderobekrog
- 1605 Bøjleknægt
- 1609 Konfektionsstativ m. stilleskrue/75 mm hjul

Løsdele

Side 32

Stålgondol

- 1630 Enkelt gondolgavl
H. 120, 150, 180, 210 cm
- 1640 Dobbelt gondolgavl
H. 120, 150, 180, 210 cm
- 1641 Mellemstykke
- 1642 Mellemstykke med u-skinne
- 1644 Bolt til gondol 8 mm
- 1645 Møtrik til gondol 8 mm
-
- 1647 Skilteholder til gondol enk./dobb.
- 1650 Bagbeklædning til gondol.
Fås i flere farver
- 1651 Dekorationsgitter 77 x 127 cm.
Passer til 150 cm gondol
- 1652 Vægbeslag til dekorationsgitter

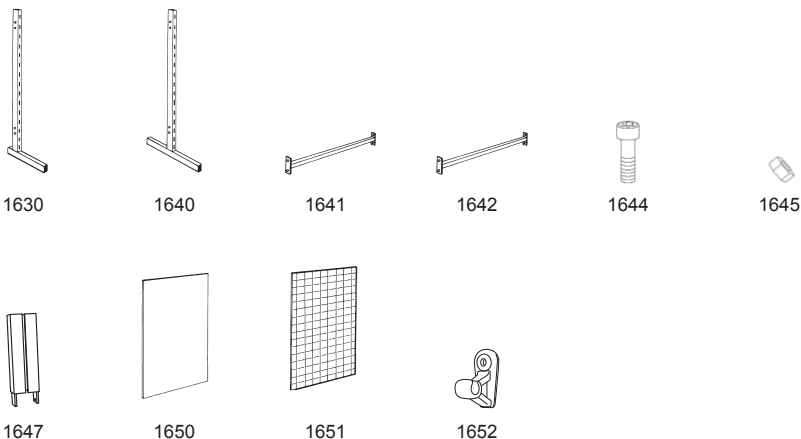

Rørsøjle

- 1690 Rørsøjle 250, 300, 350 cm
- 1691 Overflange
- 1692 Underflange

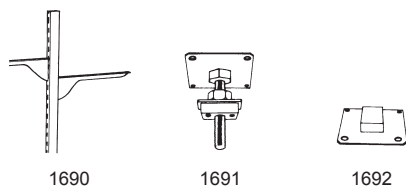

Kurve

- 1694 Selvbetjeningskurv 20 liter
- 1697 Stabelkurve STM-90
- 1697/1 Topkurv B. 86,5 D. 50,0 H. 7,0 cm
- 1697/2 Stor kurv B. 86,5 D. 54,0 H. 48,0 cm
- 1697/3 Skillerum til do.
- 1697/4 Understel med hjul
B. 86,5 D. 42,0 H. 18,0 cm

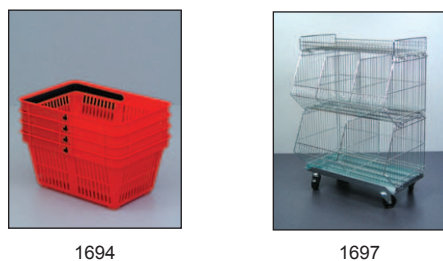

Plastkasser

- 1700 Ophængsskinne til 1710, 80 cm
- 1710/1 Stabelkasse 50,0 x 31,0 x 18,0 cm
- 1710/2 Stabelkasse 34,0 x 20,0 x 15,3 cm
- 1710/3 Stabelkasse 25,0 x 14,6 x 12,8 cm
- 1710/4 Stabelkasse 16,0 x 10,3 x 7,3 cm
-
- 1720/1 Lageræske 50,0 x 18,6 x 8,0 cm
- 1720/2 Lageræske 50,0 x 9,4 x 8,0 cm
- 1720/3 Lageræske 40,0 x 18,6 x 8,0 cm
- 1720/4 Lageræske 30,0 x 18,6 x 8,0 cm
- 1720/5 Lageræske 40,0 x 9,4 x 8,0 cm
- 1720/6 Lageræske 30,0 x 9,4 x 8,0 cm
-
- 1730/1 Skillerum til 1720/1-3-4
- 1730/2 Skillerum til 1720/2-5-6
- 1740/1 Plastkasse 40,0 x 60,0 x 12,5 cm
- 1740/2 Plastkasse 40,0 x 60,0 x 20,0 cm
- 1740/3 Plastkasse 40,0 x 60,0 x 30,0 cm

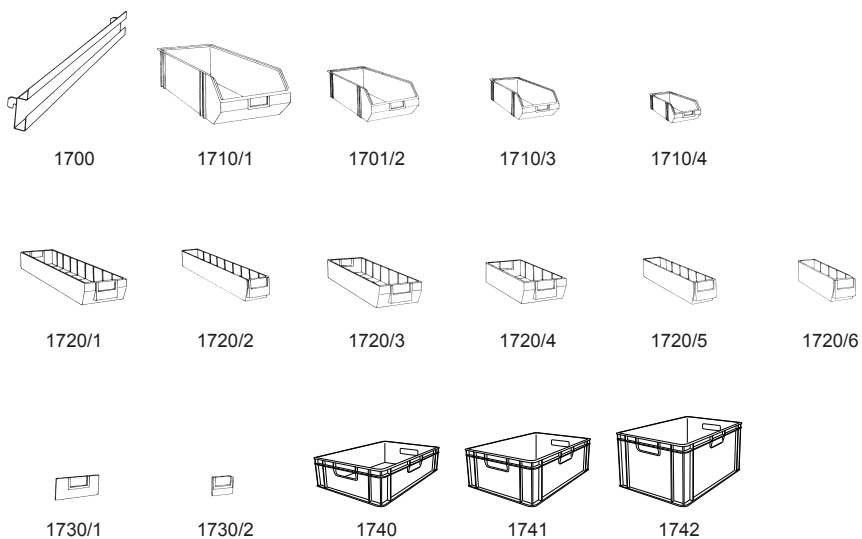

Alle plastkasser lagerføres i blå

Rillepaneler og tilbehør

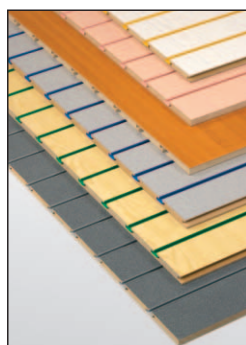

2652

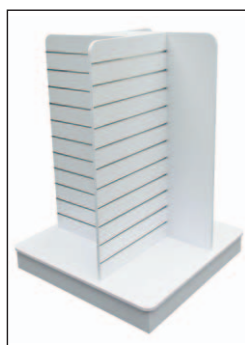

2660



1545



1581



1755



1755/1



1756



1758



1759



1759/1



1764



1765



1766



1767



1768



1768/1

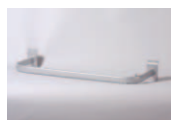

1769



1770



1771

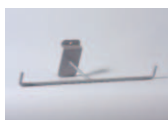

1772



1773



1774



1775



1776



1777

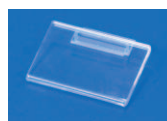

1778



1780/1

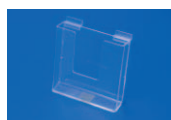

1780/2

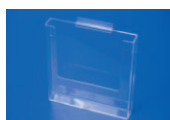

1780/3



1781

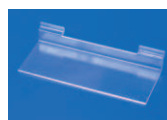

1785/1

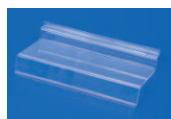

1785/2

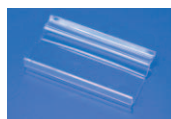

1786



1788



1790

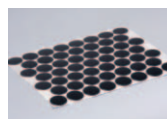

1799

2652 Rillepanel 120x240 cm
Hvid, sort, grå, ahorn

Rillepaneler leveres også tilskåret på mål.

2660 Panel display 100x100x135 cm
1545 Varekrog 5mm, 5, 10, 15, 20, 25, 30 cm
1581 Euro-krog 10, 15, 20, 25, 20 cm

1755 Hyldeknægt til træhylde 20, 25, 30, 35, 40 cm

1755/1 Hyldeknægt skrå 30 cm

1756 Hyldeknægt til glas 20, 25, 30, 35 cm

1758 Sugekop til hyldeknægt

1759 Ophængsbeslag

1759/1 Billedkrog

1764 Skohylde metal, 10x28 cm

1765 Hakarm med 10 hak

1766 Bøjleknægt med knopper 30, 40 cm

1767 Skrå knægt med 6 kroge

1768 Konfektionsknægt lige 5 cm

1768/1 Konfektionsknægt lige 30, 40 cm

1769 Konfektionsbøjle 18x60, 25x60 cm

1770 Konfektionsknægt 2step

1771 Bæltedisplay

1772 Bijouteri display

1773 Slipse display

1774 Hatteholder

1775 Trådkurv 30x61 cm

1776 Boldring Ø 150 mm

1777 Akrylkurv 20x26 cm

1778 Etiketterholder 75x50 mm, 100x75 mm

1780/1 Brochureholder A6

1780/2 Brochureholder A5

1780/3 Brochureholder A6

1781 Brochuredisplay A5, A4

1785/1 Akrylhylde 10x25 cm

1785/2 Akrylhylde med forkant 11x25 cm

1786 Akrylhylde skrå 5x16 cm

1788 Hyldeknægt alu til 8mm glashylde

1790 Hylde blå, rød, grøn, 20x60, 30x60 cm

Øvrige træ- og glashylder se side 30.

1799 Dæktap til skruerhuller selvkøb.,
hvid, sort, grå, ahorn

Brochureholdere

Ikke alle modeller er vist som billede, men beskrevet i teksten

- 1800 Brochureholder A4 6 rum sølv lodret
- 1800 Brochureholder A4 5 rum sort lodret
- 1804 Brochureholder A4 10 rum sølv lodret
- 1806 Brochureholder A4 6 rum sort vandret
- 1808 Brochureholder A4 12 rum sort vandret
- 1820 Brochurerekarusel 3x5 rum A4 chrom
- 1822 Brochurestander 3x5 rum A4 sort
- 1822 Brochurestander 3x6 rum A4 sølv
- 1824 Brochurestander 4x6 rum A4 sølv



1800

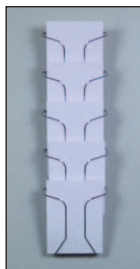

1800



1806



1820



1822



1824

- 1828 Brochurestander 4x5 rum A4 sort
- 1829 Brochurestander 3x10 rum A4 sølv
- 1830 Brochurestander 4x10 rum A4 sølv
- 1810 Brochurestander A4
- 1812 Brochureholder A4 bordmodel
- 1812 Brochureholder A5 bordmodel
- 1814 Brochureholder 3 rum A4
- 1816 Brochurestander 3x3 rum A4
- 1838 Brochurestander 5 rum A4 Enara

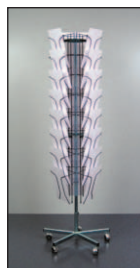

1828



1810



1812

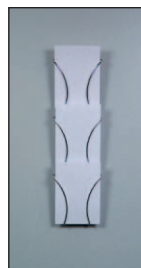

1814



1816



1838

- 1839 Visitkortholder 1 rum vandret
- 1839 Visitkortholder 1 rum lodret
- 1839 Visitkortholder 4 rum vandret
- 1840 Brochureholder til væg/bord A6 acryl
- 1841 Brochureholder til væg/bord A5 acryl
- 1842 Brochureholder til væg/bord A4 acryl
- 1843 Brochureholder 4 rum A4, A5, A6 acryl



1839

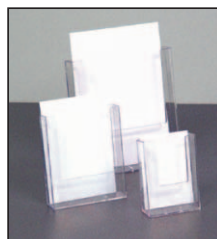

1840

1841

1842



1843

- 1844 Skilteholder acryl A6
- 1845 Skilteholder acryl A5
- 1846 Skilteholder acryl A4
- 1862 Klip-klap ramme 25 mm A4
- 1862 Klip-klap ramme 25 mm A3
- 1862 Klip-klap ramme 25 mm A2
- 1862 Klip-klap ramme 25 mm 50x70 cm
- 1862 Klip-klap ramme 25 mm 70x100 cm
- 1863 Klip-klap ramme 32 mm A4
- 1863 Klip-klap ramme 32 mm A3
- 1863 Klip-klap ramme 32 mm A2
- 1863 Klip-klap ramme 32 mm 50x70 cm
- 1863 Klip-klap ramme 32 mm 70x100 cm

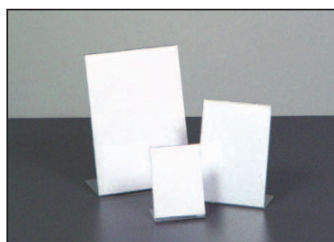

1844

1845

1846



1862-1863

Gadeskilte

- 1850 Gadeskilt hvid 50x70 cm
- 1850 Gadeskilt sølv 50x70 cm
- 1852 Gadeskilt hvid 50x70 cm med topskilt
- 1852 Gadeskilt sølv 50x70 cm med topskilt
- 1855 Gadeskilt sølv 50x70 cm klip-klap
- 1860 Inforstander sølv A4



1850



1852



1855



1860

Tilbehør til profilreoler og profilarbejdsborde

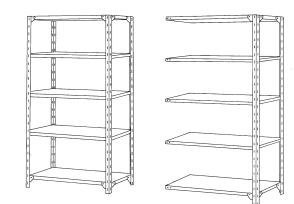

5000

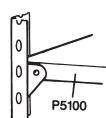

5100

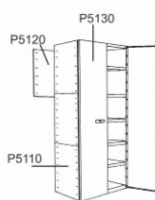

5110 5120 5130

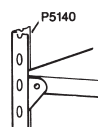

5140



5160



5180



5190

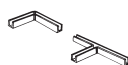

5200



5230



5235



5240



5242



4160



4160

- 5000 Komplette profilreoler (hvid eller grå)
B. 30, 40, 50, 60, 80 cm
L. pr. fag 90 cm, Højde 215 cm
- 5100 Stålhylde (hvid eller grå), 70 - 100 kg
B. 30, 40, 50, 60, 80 cm L. 90 cm
- 5110 Sideplade B. 30, 40, 50, 60, 80 cm
H. 66,5 cm,
til 2 m højde anvendes 3 plader
- 5120 Bagplade B. 90 cm H. 66,5 cm,
til 2 m højde anvendes 3 plader
- 5130 Ståldører med lås H. 100/200 cm
- 5140 Stålstænger 40 x 40 mm
30, 40, 50, 60, 80, 90, 100, 200,
215, 300 cm

- 5160 Gulvbeskytter.
Til montering af hjul eller stilleskrue
- 5180 Profilforlængerstykke
- 5190 Hyldebærer
- 5200 Plastikdupsko enkelt/dobbelt
- 5230 Hjørneplade
- 5235 Hjørneplade med styretap

- 5240 Topnøgle
- 5242 Ringgaffelnøgle 10 mm
- 4160 Bolt
- 4160 Flangemøtrik

Tilbehør til Kvikreol

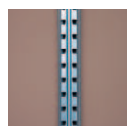

5700



5710

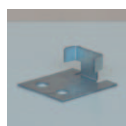

5711



5715

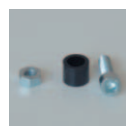

5717



5720



5730



5740



5750

- 5700 Reolben 200, 250 cm
- 5710 Gulvbeskytter plast
- 5711 Gulvbeskytter stål
- 5715 Forlængerstykke til reolben
- 5717 Samlebolt til dobbeltreol

- 5720 Udvendig hyldeprofil 100 cm
- 5730 Hyldestøtte 100 cm
- 5740 Indvendig hyldeprofil 30, 40, 50,
60, 80 cm
- 5750 Hyldeplade grå, br. 30, 40, 50,
60, 80 cm, l. 100 cm

Tilbehør til palletreoler

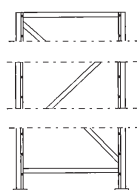

8100



8110



8135



8139

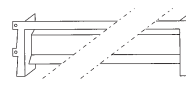

8140

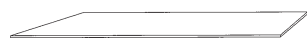

8150



8160



8160



8160



8160



8170

- 8100 Pallet-stige 5 tons (grågrøn)
B. 45, 60, 80, 100 cm,
H. 210, 250, 350 cm
- 8110 Fodplade
- 8135 Hyldestøtte L. 80, 100 cm
- 8139 Sikringspind til bærebjælke
- 8140 Bærebjælke komplet (grågrøn)
Belastningsevne: 700 - 900 kg.
L. 122, 184, 244 cm

- 8150 Hyldeplade 19 mm, spånex/hvid
Mål (se prisliste)
- 8160 Bolt M5 x 16 mm til fodplade
- 8160 Bolt M6 x 40 mm til palletstige
- 8160 Låsemøtrik M5
- 8160 Låsemøtrik M6
- 8170 Betonanker 10 x 75 mm til fodplade

WWW.PORSA.DK



Brøndby

Vallensbækvej 55
2605 Brøndby
Tlf.: 4396 5100
Fax: 4396 4240

Fyn/Jylland

Tlf.: 2190 4595

porsa@porsa.dk
www.porsa.dk